

THE INFORMATION CONTAINED IN THIS DRAWING IS THE SOLE PROPERTY OF ANDERSON POWER PRODUCTS. ANY REPRODUCTION IN PART OR WHOLE WITHOUT THE WRITTEN PERMISSION OF ANDERSON POWER PRODUCTS IS PROHIBITED.

Copyright 2012

ANDERSON POWER PRODUCTS RESERVES THE RIGHT TO ALTER PRODUCT TYPES, THEIR TECHNICAL DATA, DIMENSION, STYLE AND ACCESSORIES WITHOUT PRIOR NOTIFICATION.

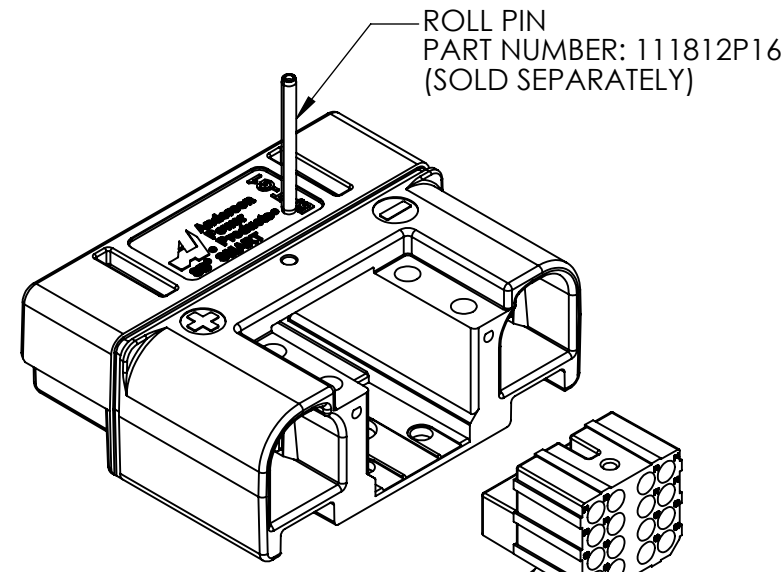
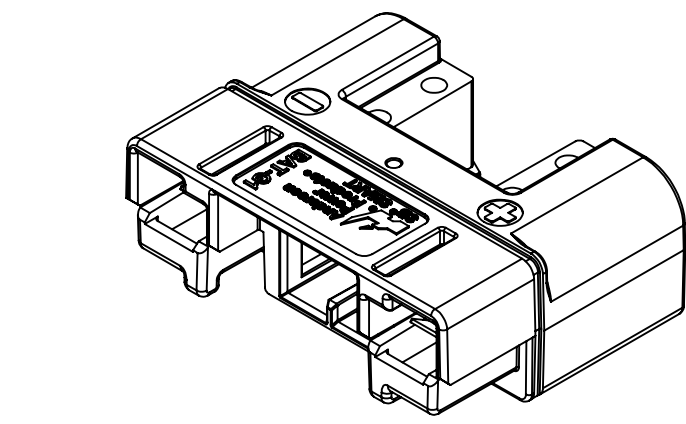
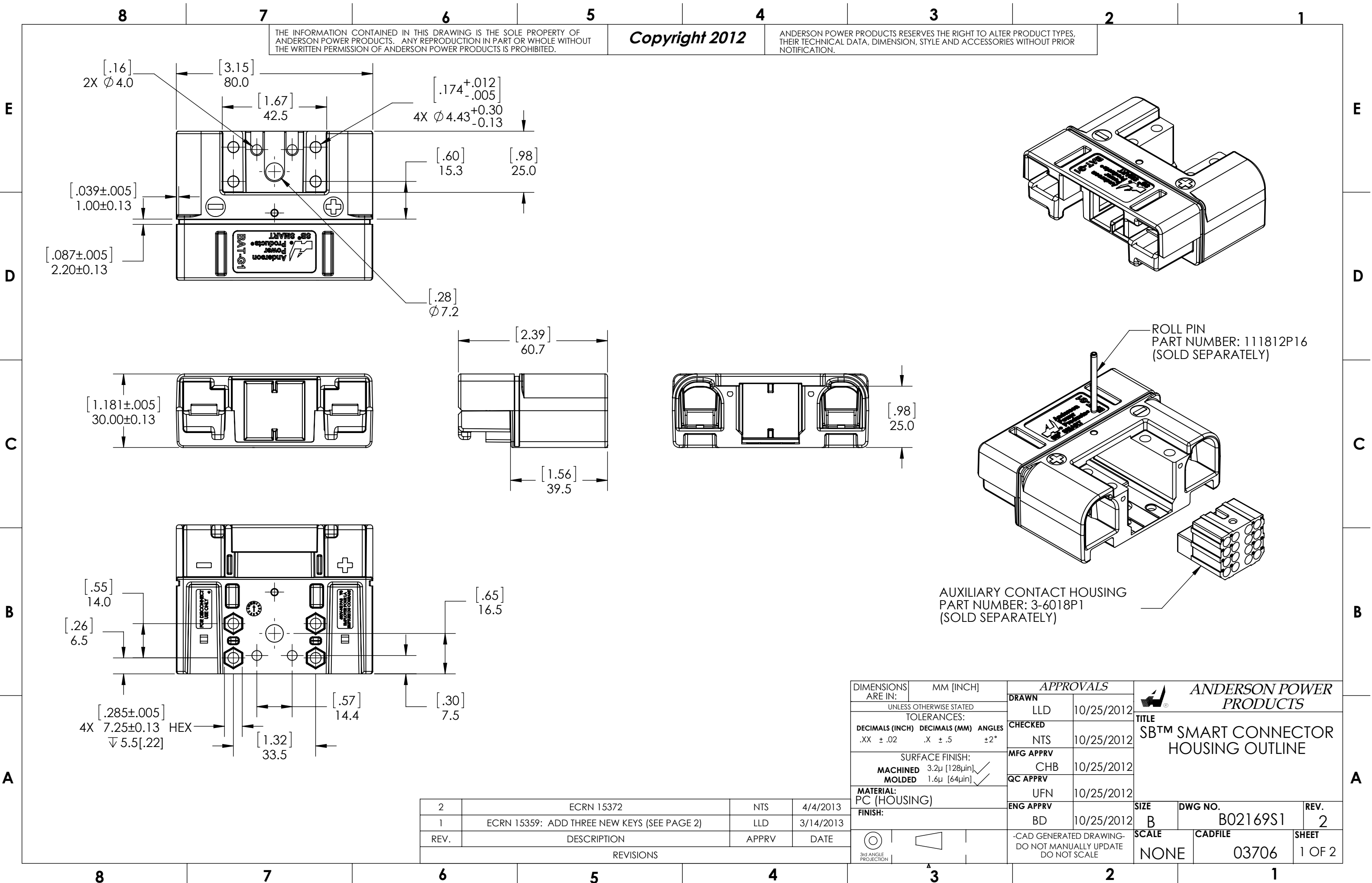

DIMENSIONS ARE IN:		MM [INCH]		APPROVALS		ANDERSON POWER PRODUCTS			
UNLESS OTHERWISE STATED				DRAWN	LLD	10/25/2012	TITLE SB™ SMART CONNECTOR HOUSING OUTLINE		
TOLERANCES:				CHECKED	NTS	10/25/2012			
DECIMALS (INCH)	DECIMALS (MM)	ANGLES		MFG APPRV	CHB	10/25/2012			
.XX ± .02	.X ± .5	± 2°		QC APPRV	UFN	10/25/2012			
SURFACE FINISH:				ENG APPRV	BD	10/25/2012	SIZE	DWG NO.	REV.
MACHINED		3.2µ [128µin]				B	B02169S1	2	
MOLDED		1.6µ [64µin]				SCALE	CADFILE	SHEET	
MATERIAL: PC (HOUSING)						NONE	03706	1 OF 2	
FINISH:						-CAD GENERATED DRAWING- DO NOT MANUALLY UPDATE DO NOT SCALE			

REV.	DESCRIPTION	APPRV	DATE
2	ECRN 15372	NTS	4/4/2013
1	ECRN 15359: ADD THREE NEW KEYS (SEE PAGE 2)	LLD	3/14/2013
REV.	DESCRIPTION	APPRV	DATE

REVISIONS

8

7

6

5

4

3

2

1

THE INFORMATION CONTAINED IN THIS DRAWING IS THE SOLE PROPERTY OF ANDERSON POWER PRODUCTS. ANY REPRODUCTION IN PART OR WHOLE WITHOUT THE WRITTEN PERMISSION OF ANDERSON POWER PRODUCTS IS PROHIBITED.

Copyright 2012

ANDERSON POWER PRODUCTS RESERVES THE RIGHT TO ALTER PRODUCT TYPES, THEIR TECHNICAL DATA, DIMENSION, STYLE AND ACCESSORIES WITHOUT PRIOR NOTIFICATION.

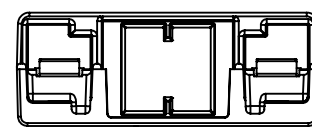
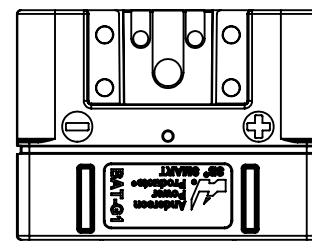

BATTERY MODULE CONNECTOR HOUSING
PART NUMBER: 115158G1

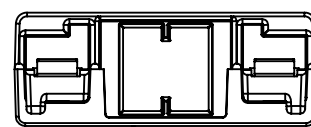
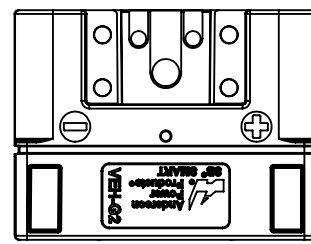

VEHICLE OR EQUIPMENT POWER INPUT CONNECTOR HOUSING
PART NUMBER: 115158G2

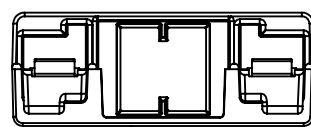
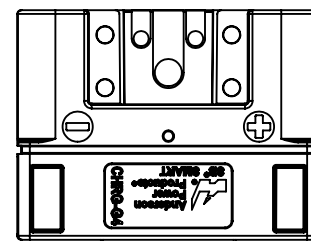

CHARGER CONNECTOR HOUSING
PART NUMBER: 115158G4

P/N	COLOR	LOGO TEXT	MATES WITH
115158G1	BLACK	BAT-G1	G2, G4
115158G2	BLACK	VEH-G2	G1
115158G4	BLACK	CHRG-G4	G1
115158G11	BROWN	BAT-G11	G12, G14
115158G12	BROWN	VEH-G12	G11
115158G14	BROWN	CHRG-G14	G11

E

E

D

D

C

C

B

B

A

A

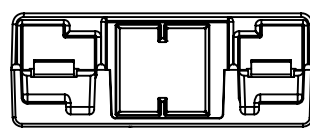
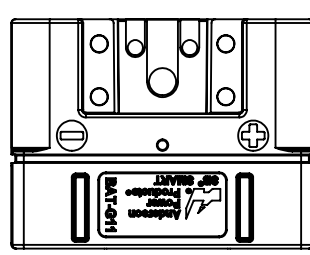

BATTERY MODULE CONNECTOR HOUSING
PART NUMBER: 115158G11

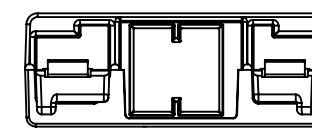
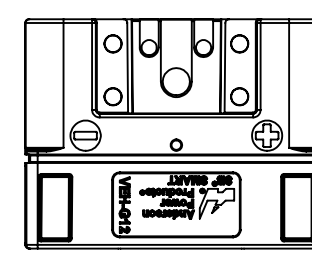

VEHICLE OR EQUIPMENT POWER INPUT CONNECTOR HOUSING
PART NUMBER: 115158G12

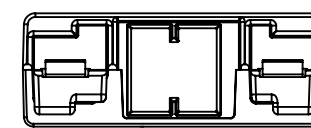
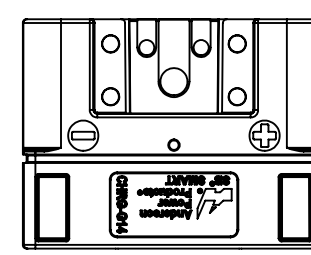

CHARGER CONNECTOR HOUSING
PART NUMBER: 115158G14

DIMENSIONS ARE IN:	MM [INCH]	APPROVALS	
UNLESS OTHERWISE STATED		DRAWN	
TOLERANCES:		LLD	10/25/2012
DECIMALS (INCH)	DECIMALS (MM)	CHECKED	
.XX ±.02	.X ±.5	NTS	10/25/2012
ANGLES ±2°		MFG APPRV	
SURFACE FINISH:		CHB	10/25/2012
MACHINED	3.2µ [128µin]	QC APPRV	
MOLDED	1.6µ [64µin]	UFN	10/25/2012
MATERIAL:		ENG APPRV	
PC (HOUSING)		BD	10/25/2012
FINISH:			

ANDERSON POWER PRODUCTS

TITLE: **SB™ SMART CONNECTOR HOUSING OUTLINE**

SIZE: **B** DWG NO.: **B02169S1** REV.: **2**

SCALE: **NONE** CADFILE: **03706** SHEET: **2 OF 2**

-CAD GENERATED DRAWING-
DO NOT MANUALLY UPDATE
DO NOT SCALE

REV.	DESCRIPTION	APPRV	DATE
-	SEE SHEET 1	-	-
REVISIONS			

8

7

6

5

4

3

2

1